

# Keysight Technologies

## Choosing the Right Power Meter and Sensor

Product Note

## Introduction

Design and manufacturing of engineering processes for RF/microwave systems have reached a status undreamed of a decade ago. Wireless communication engineers especially, faced with aggressive project schedules, must quickly select and configure power-measurement equipment that provides the accuracy and repeatability required by their innovative new modulation formats. New wireless technologies needed to support wideband data transmissions now demand power-measuring instruments and sensors for average power, as well as time-gated and peak power profiles and peak-to-average ratios, with all those measurements delivered at high measurement-data rates.

The Keysight Technologies' Inc. contribution: *unsurpassed accuracy and repeatability—by design.*



In general, power sensors are designed to match user signals and modulation types. Power meters are designed to match the user's measurement data requirements. That's why you can choose from a versatile line of 33 different power sensors and six power meters from Keysight Technologies, as shown in Table 1. In addition, Keysight offers many custom configurations for ATE system applications and other calibration, traceability, and quality processes.

This product note outlines applications considerations and the newest sensor technologies available from Keysight Technologies. It includes Keysight's new power meters and family of peak and average sensors, designed for pulsed power and the complex modulation signals of wireless communications markets. It also reviews the families of thermocouple, diode, and two-path diode-attenuator-diode sensors. It discusses the advantages and disadvantages of each sensor technology as they apply to current and near-future wireless system advances.

Not discussed is the Keysight family of thermistor sensors and the associated Keysight 432A power meter. This venerable technology now is used almost exclusively for the standardization and traceability of power measurements from the U.S. National Institute of Standards and Technology and other international standards agencies. Because the Keysight 432A power meter and thermistor sensor technology is based on the highly precise DC-substitution method, the sensors are used as transfer standards, traveling between the user's primary lab and the NIST measurement services laboratory. Users interested in such metrology power-transfer processes may request Keysight's AN 64-1, 5965-6630E and AN 64-4, 5965-8167E application notes.

Table 1. An overview of Keysight's power meters and sensors

Keysight's power sensors	Keysight power meters				
	EPM-P series peak, average, and time gating E4416A single Ch E4417A dual Ch	EPM series Averaging E4418B single Ch E4419B dual Ch	System power meters 70100A MMS E1416A VXI	P-series peak, average, and time gating N1911A single Ch N1912A dual Ch	P-series modular peak, average, and time gating N8262A dual Ch
Thermocouple 8480A/B/H-family R/Q 8486A (11 models)	■	■	■	■	■
Diode 8480D-family 8486-W/G-family (7 models)	■	■	■	■	■
Diode sensors with extended range E4412A/13A (2 models)	■	■		■	■
Two-path-diode-stack E9300 family (7 models)	■	■		■	■
Peak and average sensors E9320 family (6 models)	■			■	
Peak and average sensors N1920 family (2 models)				■	■
Diode sensors USB average power sensor U2000 family (4 models)		<power measurement without separate power meter>			

## Power Measurements on Complex Modulation Wireless Signals

Digital vector modulation became the modulation of choice as the digital revolution swept over communication systems some 20 years ago. The need to pack the maximum amount of digital data into the limited spectrum of cellular and data transmission systems made it an obvious choice. RF power measurements for these new complex phase/amplitude formats call for careful application analysis of the test signals.

The advent of wireless communications technology accelerated the migration from analog to digital modulation formats. Soon came an alphabet soup of digital modulation formats: BPSK, QPSK, 8-PSK, 16 QAM, etc. Then came important variations such as pi/4-DQPSK. Many systems used data streams which depended on time-division-multiple-access (TDMA) technology (example: GSM). Other system developers introduced a highly competitive code-division-multiple access (CDMA) format (recent example; IS-95A).

Having transmitters at both the base stations and in the individual wireless handsets requires the most creative designs to preserve frequency spectrum and reduce power drain. Whether you use a TDMA system, which feeds multiple carriers through a common output amplifier, or a CDMA system, which encodes multiple data streams onto a single carrier with a pseudo-random code, the resulting transmitted power spectrum features almost white-noise-like characteristics.

Just like white noise, the average power of the transmitted signal is only one of the important parameters. Because of the statistical nature of multiple carrier systems, signal peak-to-average power ratio is crucial, because instantaneous peak powers can approach ratios of 10 to 30 times the average power, depending on formats and filtering.

Those high peak-to-average power ratios imply dangers in saturation of the output power amplifiers. When saturation occurs, the outer symbol locations compress, increasing bit errors and system unreliability. System designers handle this effect by “backing-off” the power amplifiers from their maximum peak ratings to assure that signal peak power operation is always within their linear range.

Therefore, all of these technologies require precise characterization of the pulse performance of their systems' amplifier power output, including peak-to-average power ratios and time-gated parameters for profiling the pulsed signals, which ensure conformity to specified limits.

## Understanding Sensor Technologies

### Thermocouple Sensors

Thermocouples work because the temperature difference between two dissimilar metals at their hot and cold junction creates voltage. Because thermocouple sensors absorb the RF/microwave signal and heat the “hot” junction element, they give the correct average power for all types of signal formats from continuous wave (CW) to pulsed to complex digital modulation, regardless of the harmonic content, waveshape, or distortion of the signal. Historically, this made thermocouple power sensors the preferred sensor type for systems with complex modulation formats, as test engineers could be assured that the sensor responded to the total aggregate power across its entire dynamic range. A radar’s peak pulse power was often computed from the average power value and a knowledge of the system duty cycle.

However, thermocouple sensors typically have a dynamic range of only 50 dB, from  $-30$  dBm ( $1 \mu\text{W}$ ) to  $+20$  dBm ( $100 \text{ mW}$ ). A common measurement made on wireless systems is the “mute” test, where the output of the power amplifier is disabled. Thermocouple sensors are required for power amplifier measurements but are not sensitive enough for the mute-test power levels, which typically are  $>-55$  dBm. This restricted sensor dynamic range makes measuring the lower power levels a slow and cumbersome process, involving swapping thermocouple sensors for diode sensors and then recalibrating measurement paths. Even measurements at the low end of the specified range of thermocouple sensors (typically  $-25$  to  $-30$  dBm) require many averages to produce an accurate, stable reading.

### Diode Sensors

Diodes convert high-frequency energy to DC by means of their rectification properties, which arise from their non-linear current-voltage characteristics. Figure 1 shows a typical diode detection curve starting near the noise level of  $-70$  dBm and extending up to  $+20$  dBm. In the lower “square-law” region the diode’s detected output voltage is linearly proportional to the input power ( $V_{\text{out}}$  proportional to  $V_{\text{in}}^2$ ) and so measures power directly. Above  $-20$  dBm, the diode’s transfer characteristic transitions toward a linear detection function ( $V_{\text{out}}$  proportional to  $V_{\text{in}}$ ), and the square-law relationship is no longer valid.

Traditionally, diode power sensors have been specified to measure power over the  $-70$  to  $-20$  dBm range, making them the preferred sensor type for applications that require highly sensitive measurements, such as verifying input levels in receiver sensitivity tests. In applications that require fast measurement, diode sensors are the chosen over thermocouple types because of their quicker response to changes of input power. The Keysight 8480 series D-suffix sensors are examples of this high-sensitivity diode technology.

When testing from  $-70$  dBm up to  $+20$  dBm is necessary, as has become increasingly the case, the traditional approach has been to use a diode sensor to cover the low end and a thermocouple sensor for the high end. In a high-volume manufacturing environment, this dual measurement configuration places a serious demand on test time limitations, especially if optimum accuracy must be maintained.

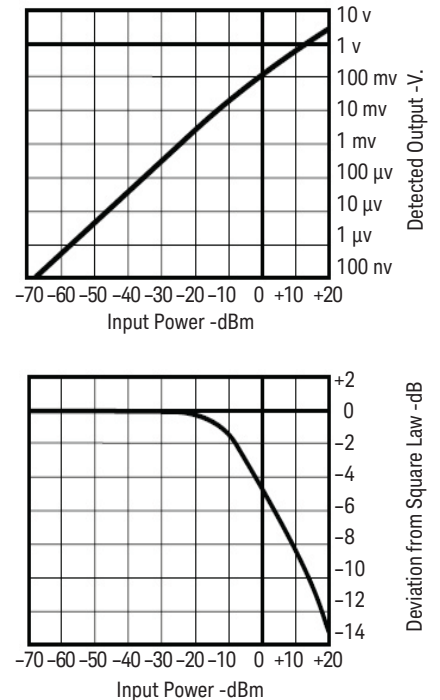

Figure 1. The diode detection characteristic ranges from the square-law region through a transition region to linear detection.

## Extended Dynamic Range Diode Sensors

A common approach to extending the dynamic range of diode power sensors beyond their square-law region has been the use of correction factors. Correction factors, derived from a CW source, compensate for the deviation from square law in the transition region (approximately -20 to 0 dBm) and the linear detection region (above 0 dBm) and are stored in the sensor's EEPROM. This results in a single sensor that can accurately measure CW and constant-amplitude signals from -70 dBm up to +20 dBm.

However, many commonly used complex digital modulation schemes in today's wireless communications systems do not exhibit constant amplitude, GSM being a notable exception. With signals such as CDMA and TDMA, the correction factors, set by CW performance, lead to additional inaccuracies, on top of the usual mismatch, reference-source, and instrumentation-measurement uncertainties.

With CDMA signals, average power requirements are for accurate measurements in the presence of high peak-to-average power ratios and often exhibit a dynamic range greater than 50 dB. Another issue with the compensated single-diode approach to measuring such high peak-to-average signals is that reflections of a test signal's low harmonics increase above the square-law region. This introduces greater mismatch errors and the potential of stray signal distortion in the device under test.

This CW compensation technology is used in the Keysight E4412A/13A sensors, and --as explained above-- caution should be used when choosing this sensor technology for non-CW and constant-amplitude signals. A typical application might be for power sensing and stabilization in a metrology laboratory where CW signals are often used as test sources

## Two-Path Diode-Stack Sensors

The ideal sensor would combine the accuracy and linearity of a thermal sensor with the wide dynamic range of the corrected diode approach. Keysight Technologies met this need and design challenge by creating a new family of power sensors in the E-series, based on a dual-path, diode-attenuator-diode topology. This topology has the advantage of always maintaining the sensing diodes within their square-law region and therefore responding correctly to complex modulation formats.

The E-series E9300 power sensors are implemented as a Modified Barrier Integrated Diode (MBID). The MBID is comprised of a two-diode stack pair for the low power path, a resistive attenuator and a five-diode stack pair for the high power path, as shown in Figure 2. Only one path is active at a time, and switching between paths is fast, automatic, and transparent to the user, effectively producing an 80 dB dynamic range.

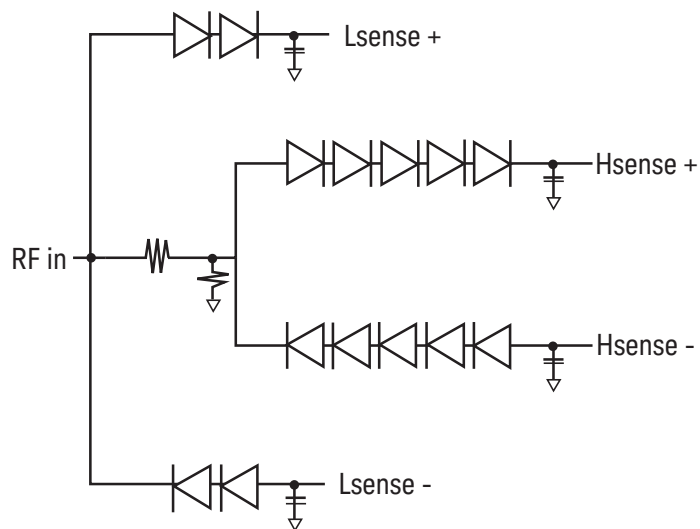

Figure 2. Schematic of the diode-attenuator-diode sensing element

This innovative approach has the additional advantage of making the sensor capable of handling higher power levels without damage, than is possible using diode sensors with extended dynamic range. This is particularly useful with W-CDMA signals, which exhibit high peak-to-average ratios. The MBID sensors, which operate at  $-60$  dBm to  $+20$  dBm, have a maximum average power specification of  $+25$  dBm and  $+33$  dBm peak ( $<10$   $\mu$ s duration). This means that the full 80 dB dynamic range can be used to measure signals that simultaneously have both high peak power and high average power.

The new sensor technology facilitates an inherently broadband average power-measurement technique, free of the bandwidth or dynamic range tradeoff considerations found in sampled techniques. These sensors are an ideal fit for users who need the flexibility to make wideband average power measurements. Together with the E-series E9300 power sensors, the companion Keysight EPM power meters (E4418B/19B) are capable of accurately measuring the power of modulated signals over a wide dynamic range, regardless of signal bandwidth.

The E4418B/19B meters are ideal for all power-measuring applications, which do not require time-gated power parameters or peak power measurements.

## Peak and Average Power Sensors

The Keysight E9320 family of peak and average power sensors covers the 50 MHz to 6/18 GHz frequency range and -67 to + 20 dBm power range. When teamed with the new Keysight EPM-P series power meters (E4416A/17A), the combination can handle test signals up to 5 MHz modulation bandwidth. The meters' 20 Msamples/second continuous sample rate permits fast measurement speed, via the GPIB, of up to 1,000 corrected readings per second. This makes it ideal for use in automatic test-system applications.

Keysight peak and average power sensors are designed for characterizing pulsed and complex modulation signals. They feature two-mode operation: **Normal** for most average and peak measurements (with or without time gating), and **Average only** for average power measurements on low level or CW-only signals. Both modes use the same diode-sensor "bulkhead" element. The signal processing is provided by two amplification paths, each optimized to different data requirements. In the average-only mode, amplification and chopping parameters are much the same as in previous Keysight diode sensors.

In the normal mode, the separate path pulse amplifier provides maximum bandwidths of 300 kHz, 1.5 MHz or 5 MHz, allowing the user to match the test signal's modulation bandwidth to the sophisticated instrument data processing. This permits the meter to measure burst average and peak power, to compute peak-to-average ratios, and to display other time-gated pulse power profiles on the power meter's large LCD screen. It can also measure and display other complex wideband modulation formats whose envelopes contain high frequency components up to 5 MHz.

Measurement accuracy is enhanced without compromise, because the sensors store three-dimensional calibration data in an EEPROM, resident in each sensor. The data is unique to each sensor and consists of calibration factor versus frequency versus power input versus temperature. Upon power-up, or when the sensor cable is connected, these calibration factors are downloaded into the EPM-P series power meters.



## Bandwidth Considerations

The power-measurement system, comprising the sensor and meter, has its maximum video<sup>1</sup> bandwidth defined by the E9320 sensor. To further optimize the system's peak power dynamic range, the bandwidth inside the meter can be selected to **High**, **Medium** and **Low**, as detailed in Table 2.

The Off filter mode provides fast settling times and minimal overshoot. When users need to measure the peak power of multiple signal types within a single sensor by considering the dynamic range of the bandwidth settings shown in Table 2, they can determine if they require only one sensor or need multiple sensors for their application(s).

Table 2. E9320 sensor bandwidth versus peak power dynamic range

Sensor model	Video bandwidth / max. peak dynamic range			
	High	Medium	Low	Off
6 GHz /18 GHz				
E9321A/E9325A	300 kHz / -42 dBm to +20 dBm	100 kHz / -43 dBm to +20 dBm	30 kHz / -45 dBm to +20 dBm	-40 dBm to +20 dBm
E9322A / E9326A	1.5 MHz / -37 dBm to +20 dBmz	300 kHz / -38 dBm to +20 dBm	100 kHz / -39 dBm to +20 dBm	-36 dBm to +20 dBm
E9323A / E9327A	5 MHz / -32 dBm to +20 dBm	1.5 MHz / -34 dBm to +20 dBm	300 kHz / -36 dBm to +20 dBm	-32 dBm to +20 dBm

## Versatile User Interface

The E4416A/17A meters feature a user-friendly interface and powerful display controls. Hard keys control the most-frequently-used functions such as sensor calibration and triggering, while softkey menus simplify configuring the meter for detailed measurement sequences. A save/recall menu stores up to 10 instrument configurations for easy switching of test processes.

For time-gated measurements, the EPM-P series meters excel in versatility. Four independent gate periods with four delay times can each accommodate three different parameters such as average, peak, and peak-to-average-power. Each gate can then manipulate the three parameters into two computed parameters (F-feeds) such as F1 minus F2 or F1/F2, to be displayed in one of the four window partitions. This computational power is particularly valuable in TDMA scenarios such as GSM, GPRS, EDGE, and IS-136 where various simultaneous combinations of computed parameters are required.

<sup>1</sup> The video bandwidth is the bandwidth detectable by the sensor and meter over which the power is measured, and is sometimes referred to as the modulation bandwidth.

The large LCD can be configured to provide a variety of measurement formats, such as a four-line display to help interpret and compare measurement results, or a large character readout to permit viewing from a distance, or a graphical representation of the pulse.

Figure 3 shows typical time-gated power measurements on a GSM signal. Gate 2 provides the burst average power over the “useful” GSM time period, and Gate 1 indicates the peak power over the complete timeslot. Thus, a peak-to-average ratio measurement can be obtained by combining Gate 1–Gate 2 (in dB).

This peak-to-average measurement is made on two different gate times and should not be confused with the peak-to-average ratio measurement in a single gate. A pulse droop measurement can be obtained from the subtraction of the two powers: Gate 3–Gate 4. With the four-line numeric display, all three of these measurements can be displayed simultaneously on the LCD screen, along with the peak power from Gate 1.

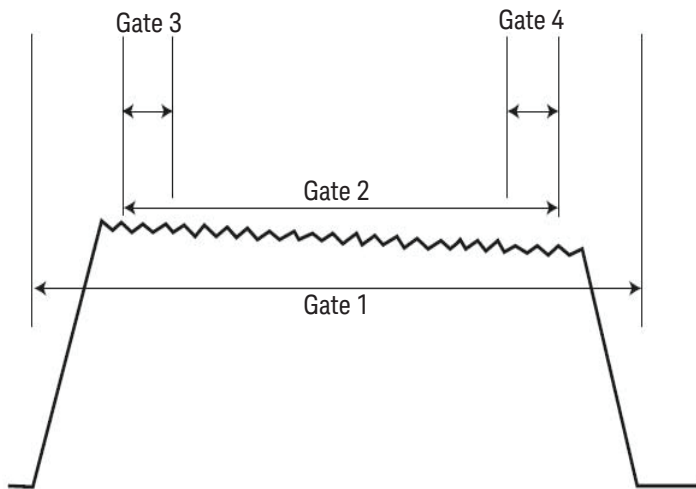

Figure 3. Powerful data configuration routines permit measurements during four gate times, each with two data “feeds” for display. Computed parameters such as peak-to-average ratio can also be displayed.

The E4416/17A power meters measure peak and average powers at user-designated time-gated periods in a test waveform. From that they compute the peak-to-average power ratio. This is a required parameter for assuring that wireless power amplifiers don’t operate into their compression region. The term Crest Factor is a functionally similar ratio, but one based on voltage parameters: peak to rms. Since there is a small difference in values, Keysight power meters do not compute or display the crest factor.<sup>1</sup>

<sup>1</sup> Definition of crest factor (pulse carrier): The ratio of the peak pulse amplitude to the root-mean-square amplitude.

## Wideband Power Sensors

The Keysight N1920A family of peak and average power sensors presently covers frequencies ranging from 50 MHz to 18/40 GHz and power ranges of -35 dBm to +20 dBm. When the N1920A series power sensor teams up with the Keysight P-series power meters (N1911A and N1912A) or P-series modular power meter (N8262A), this combination can handle up to 30 MHz of modulation bandwidth signal. The meter's 100 Msamples/second continuous sampling rate allows fast measurement speed, via the GPIB or LAN, of up to 1500 corrected readings per second. This is an added advantage for applications related to research and development, aerospace and defense, wireless communications, and wireless networking.

The 30 MHz video bandwidth of the N1920A series wideband power sensor coupled with its 100 Msamples/second continuous sampling rate, fulfills the requirements for capturing high burst rates and fast time varying power levels. These are the characteristics of the Wireless Metropolitan Microwave Access (WiMAX) signal with the bandwidth of 1.25 MHz – 28 MHz (defined by IEEE 802.16).

## USB Power Sensors

The Keysight U2000 family of USB-based average power sensor covers frequencies ranging from 9 kHz to 24 GHz and power ranging from -60 dBm to +20 dBm. The U2000 series USB power sensor allows the power measurement readings to be displayed on a PC or on other Keysight instruments without the need for a separate power meter. The compact U2000 series offers the same functionality and performance as the conventional power meter and power sensor. This is a cost-effective solution that leverages the latest diode sensor technologies.

With the combined functionality of power meter and power sensor in the U2000 series power sensor returns power-measurement readings and displays them on your PC via the USB cable. No external power supply is required to power up the sensor because it utilizes the power from the USB port of the PC. The U2000 series power sensor consists of built-in triggering circuit that enables measurement synchronization with the external instrument or event; for instance, to control the timing of capturing a pulse signal.

The U2000 series power sensor provides internal zeroing that makes it unnecessary to disconnect or power+ off the device under test. A switching circuit is integrated into each USB power sensor, so users can perform zeroing while the sensor is still connected to the device under test.

## Applications

Table 3 presents an applications profile for the E-series, P-series, and U2000 series sensors. Each sensor technology fits some applications best, and gives the user data for making an informed choice.

Table 3. Genealogy of Keysight E-series, P-series, and U2000 series sensors

<b>E-series power sensor families</b>	<b>Power measurement types</b>	<b>Frequency range<sup>1</sup></b>	<b>Power range<sup>2</sup></b>
E441XA family (extended range)	CW and constant amplitude signals	10 MHz to 26.5 GHz	-70 to +20 dBm
E9300 family two-path-diode-stack	CW and average power all modulation formats	9 kHz to 18 GHz	-60 to +44 dBm
E9320 family peak and average	CW, peak and average time-gated	50 MHz to 18 GHz	-67 to +20 dBm
N1920A family peak and average	CW, peak and average time-gated	50 MHz to 40 GHz	-35 to +20 dBm
U2000 family two-path-diode-stack	CW and average power all modulation formats	9 kHz to 24 GHz	-60 to +20 dBm

## Pre-Defined Measurement Setups

In addition to all the flexibility designed into the E4416/17A meters for custom measurements, Keysight has also studied the specific measurement and characterizations required for common wireless systems. To this end, the meters feature pre-defined measurement setups for the following systems: GSM, EDGE, NADC, iDEN, Bluetooth, IS-95 CDMA, W-CDMA, and cdma2000. Such built-in routines simplify and speed up the configuration test stations in production environments.

The N1911/12A power meters and N8262A modular power meter are loaded with comprehensive and specific pre-defined test setups for common measurements. These measurements are used in radar and wireless communications: Radar, MCPA, WLAN, 1xEVDO, 1xEV-DV, TD-SCDMA, HiperLan2, WiMAX, DME, and DME-PRT. To get started, the available easy-to-use menu structure enables you to set up quickly through measurement sequences.

<sup>1</sup> Sensor dependent

<sup>2</sup> Refer to N1918A Power Analysis Manager Technical Overview, 5989-6613EN

## External Calibration-Free Measurement

The P-series power sensors (N1921/22A) are the first to provide *internal zero and calibration*, which eliminates the need for sensor calibration using an external reference source. Keysight's patented technology that integrates a DC reference source and switching circuits into each power sensor allows you to zero and calibrate the sensor while the power sensor is still connected to the device under test. This feature makes it unnecessary to connect and disconnect the power sensor from the calibration source. Thus, it helps to reduce test times, measurement uncertainties, and wear and tear on the connectors, especially when the power sensor is used in manufacturing and automated test environments where every second and connection counts. The power sensors can be embedded within test fixtures without the need to switch in reference signals.

## Comprehensive Power, Time, and Statistical Measurements

The N1921/22A wideband power sensors, N1911/12A power meters, and N8262A modular power meter offer comprehensive measurements that are able to fulfill the requirements of many power applications in research and development and manufacturing. These devices provide:

- Peak, power, average power, and peak-to-average ratio power measurements
- Time-gated and free-run measurement modes
- Automatic rise time, fall time, pulse width, time-to-positive occurrence, and time-to-negative occurrence time measurements
- Complementary Cumulative Distribution Function (CCDF)

PC-based measurement software (N1918A)<sup>2</sup> offers even more pulse-parameters and statistical analysis capability, for performance approaching that of a traditional peak-power analyzer.

## Keysight Sensor Families

Table 4 presents the complete applications picture for the sensor families and how they support a wide variety of applications, from metrology to the latest wireless signal formats.

Table 4. Keysight sensor applications chart

Recommended sensor application chart	Signal characteristics								
	CW				Modulated				
	CW	Pulse/averaged	Pulse/profiled	AM/FM	Wireless standards				
Typical application examples	Metrology lab	Radar/navigation	Radar/navigation	Mobile radio	TDMA GSM EDGE IS-136 IDEN	CDMA IS-95 Bluetooth	W-CDMA 3GPP cdma2000	HSDPA/HSUPA	WLAN/WiMAX
Sensor technology									
Thermocouple sensors	■	■		■	■ Avg. only	■ Avg. only	■ Avg. only	■ Avg. only	■ Avg. only
Diode sensors	■	■		■	■ Avg. only	■ Avg. only	■ Avg. only	■ Avg. only	■ Avg. only
Diode sensors compensated for extended range	■			FM only					
Two-path-diode-stack	■	■		■	■ Avg. only	■ Avg. only	■ Avg. only	■ Avg. only	■ Avg. only
Peak and average sensors (video BW)	■	■ (5 MHz)	■ (5 MHz)	■	■ (300 kHz) timegated	■ (1.5 MHz) peak, avg., peak/avg.	■ (5 MHz) peak, avg., peak/avg.	■ (30 MHz) peak, avg., peak/avg.	■ (30 MHz) peak, avg., peak/avg.

## Keysight Power Sensor Characteristics

Table 5. Keysight power sensor

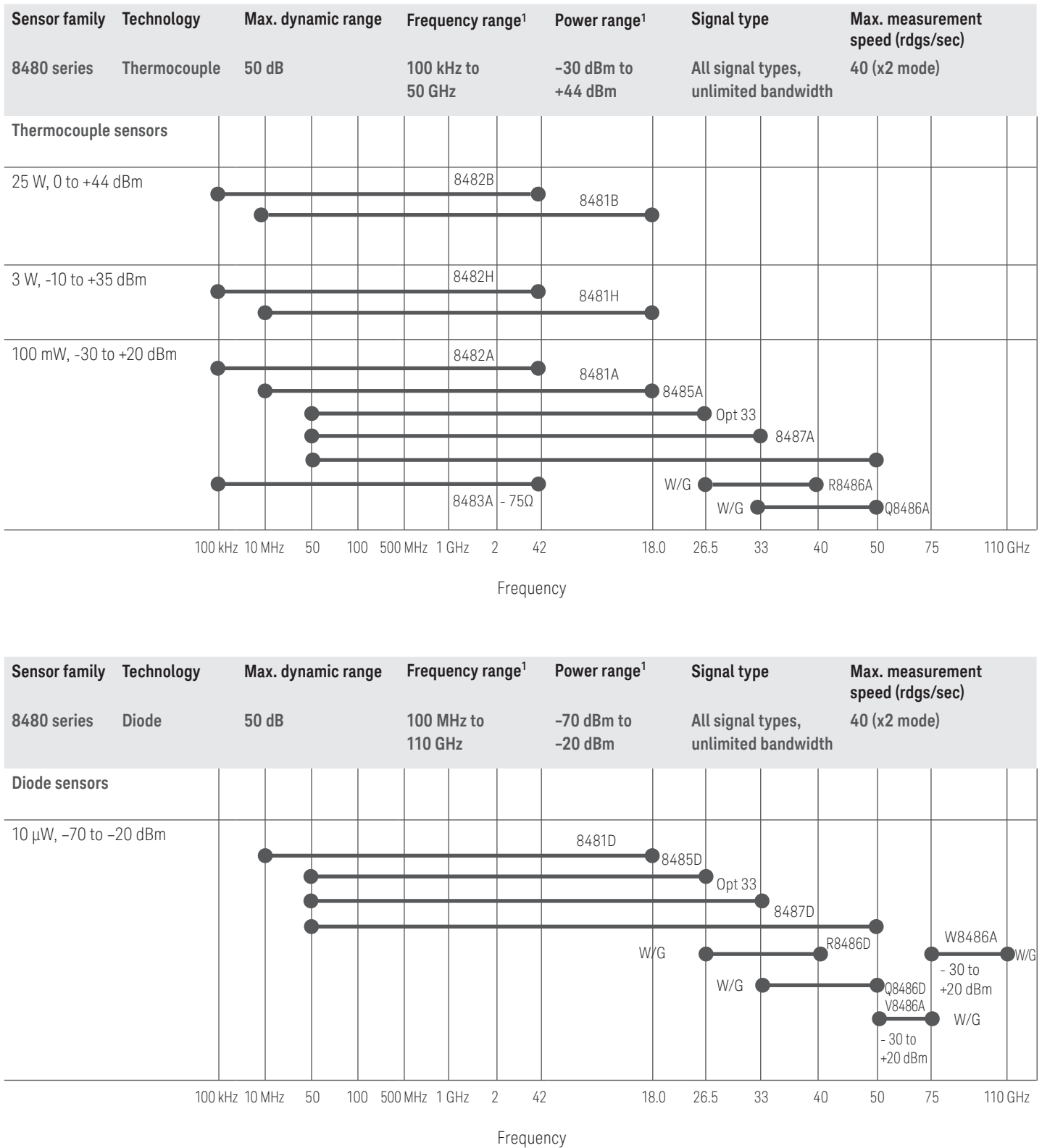

## Keysight Power Sensor Characteristics (continued)

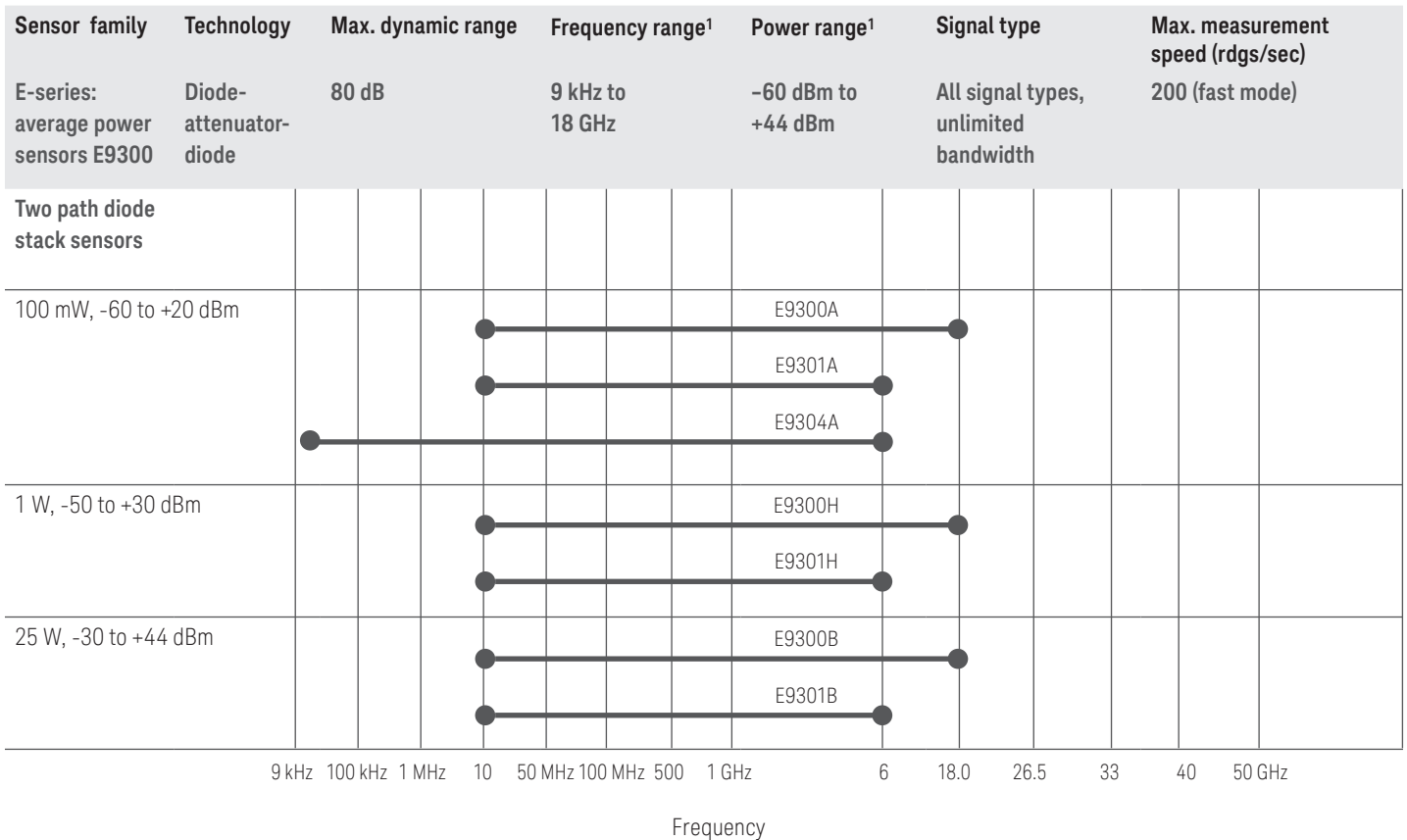
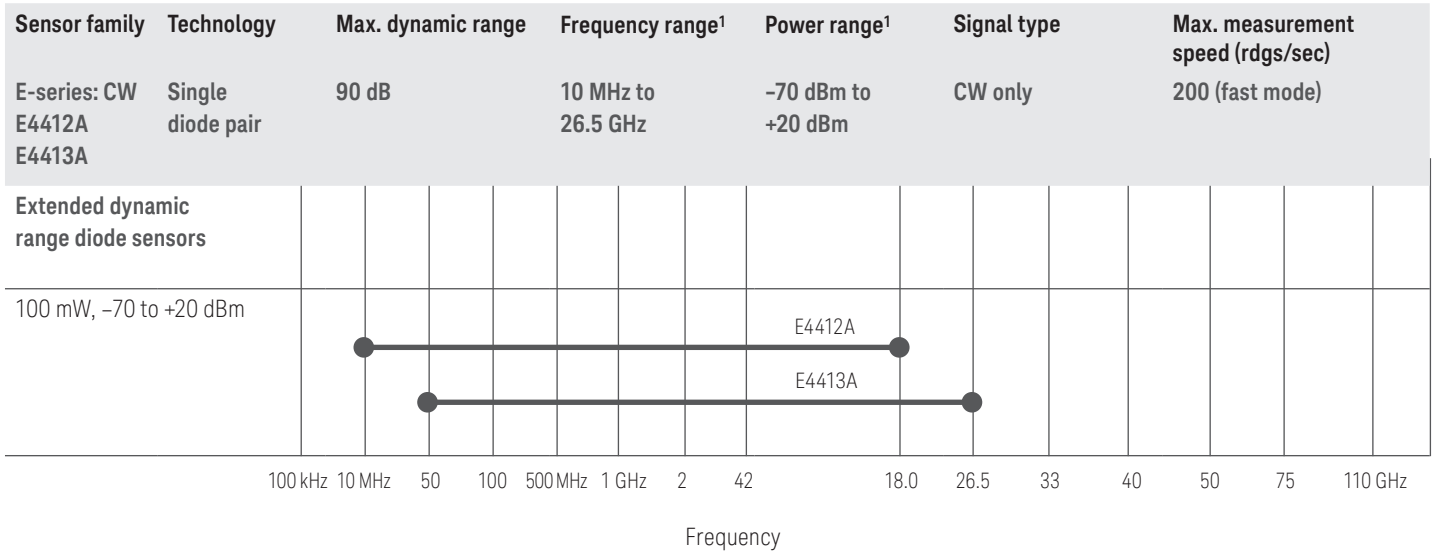

<sup>1</sup> Sensor dependent



## Keysight Power Sensor Characteristics (continued)

Sensor family	Technology	Max. dynamic range	Frequency range <sup>1</sup>	Power range <sup>1</sup>	Signal type	Max. measurement speed (rdgs/sec)
E9320-series <sup>2</sup> peak and average E9321/22/23A E9325/26/27A	Single diode pair, two-path	87 dB	50 MHz to 18 GHz	-67 to +20 dBm	CW, avg, peak	Up to 1000

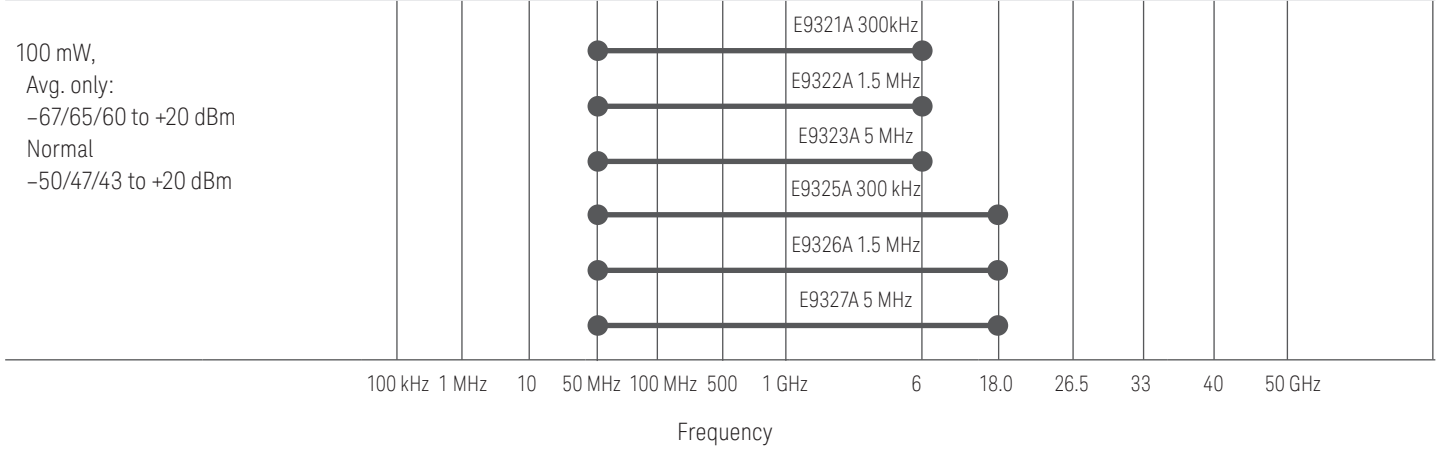

Sensor family	Technology	Max. dynamic range	Frequency range <sup>1</sup>	Power range <sup>1</sup>	Signal type	Max. measurement speed (rdgs/sec)
N1920-series <sup>3</sup> peak and average N1921A/22A	Single diode pair, two-path	55 dB	50 MHz to 40 GHz	-35 to +20 dBm	CW, avg, peak	Up to 1500

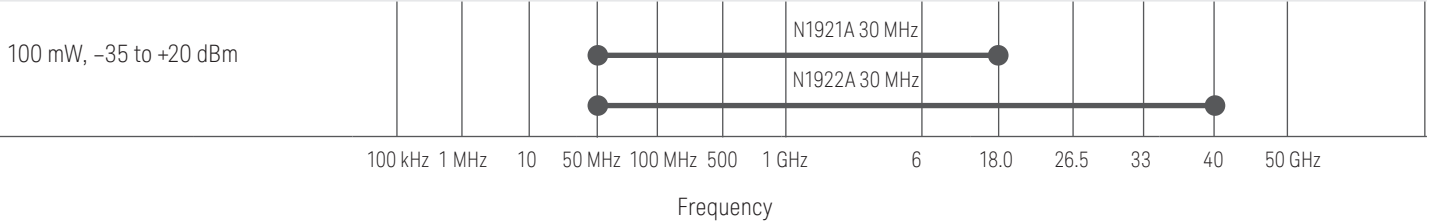

Sensor family	Technology	Max. dynamic range	Frequency range <sup>1</sup>	Power range <sup>1</sup>	Signal type	Max. measurement speed (rdgs/sec)
U2000-series average power sensors U2000/01/02/04A	Diode-attenuator-diode	80 dB	9 kHz to 24 GHz	-60 to +20 dBm	All signal types, unlimited bandwidth	250 (fast mode)

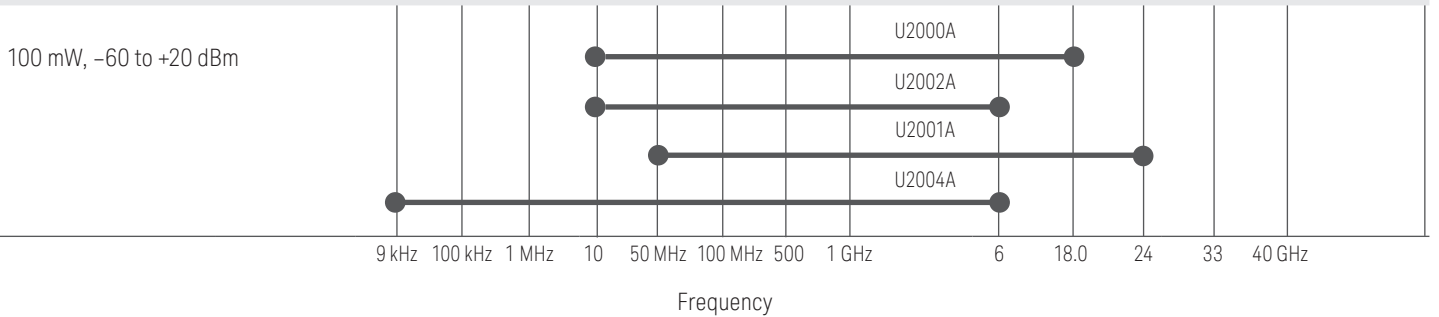

1 Sensor dependent

2 Peak and average sensors must be used with an E9288A, B, or C sensor cable, and only operate with the E4416A/17A power meters.

3 Peak and average sensors must be used with the N1921/22A power meters.

## Related Literature

<b>Publication title</b>	<b>Pub number</b>
Product Overview: <i>EPM-P Series Power Meters and E9320 Power Sensors</i>	5980-1471E
Technical Specifications: <i>EPM-P Series Power Meters and E9320 Power Sensors</i>	5980-1469E
Brochure: <i>EPM Series Power Meters</i>	5965-6380E
Data Sheet: <i>EPM Series Power Meter, E-Series and 8480 Series Power Sensor</i>	5965-6382E
Configuration Guide: <i>EPM Series Power Meters, E-Series Power Sensors</i>	5965-6630E
Product Overview: <i>E-Series E9300 Power Sensors</i>	5968-4960E
Application Note 64-1: <i>Fundamentals of RF and Microwave Power Measurements</i>	5965-6630E
Application Note 64-4: <i>4 Steps for Making Better Power Measurements</i>	5965-8167E
Technical Overview: <i>P-Series Power Meters and P-Series Wideband Power Sensor</i>	5989-1049EN
Technical Overview: <i>N8262A P-Series Modular Power Meter and Power Sensor,</i>	5989-6606EN
Technical Overview: <i>U2000 Series USB Power Sensor</i>	5989-6279EN

## Evolving Since 1939

Our unique combination of hardware, software, services, and people can help you reach your next breakthrough. We are unlocking the future of technology.  
From Hewlett-Packard to Agilent to Keysight.

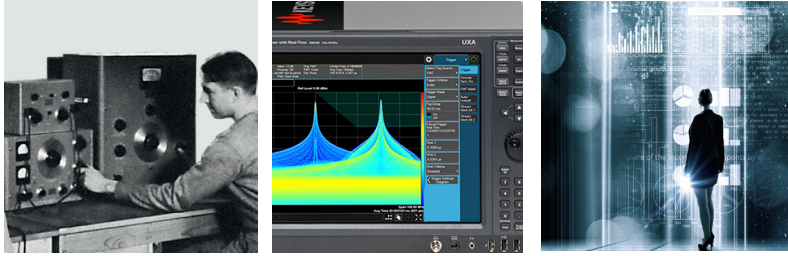

For more information on Keysight Technologies' products, applications or services, please contact your local Keysight office. The complete list is available at: [www.keysight.com/find/contactus](http://www.keysight.com/find/contactus)

### Americas

Canada	(877) 894 4414
Brazil	55 11 3351 7010
Mexico	001 800 254 2440
United States	(800) 829 4444

### Asia Pacific

Australia	1 800 629 485
China	800 810 0189
Hong Kong	800 938 693
India	1 800 11 2626
Japan	0120 (421) 345
Korea	080 769 0800
Malaysia	1 800 888 848
Singapore	1 800 375 8100
Taiwan	0800 047 866
Other AP Countries	(65) 6375 8100

### Europe & Middle East

Austria	0800 001122
Belgium	0800 58580
Finland	0800 523252
France	0805 980333
Germany	0800 6270999
Ireland	1800 832700
Israel	1 809 343051
Italy	800 599100
Luxembourg	+32 800 58580
Netherlands	0800 0233200
Russia	8800 5009286
Spain	800 000154
Sweden	0200 882255
Switzerland	0800 805353
	Opt. 1 (DE)
	Opt. 2 (FR)
	Opt. 3 (IT)
United Kingdom	0800 0260637

For other unlisted countries:  
[www.keysight.com/find/contactus](http://www.keysight.com/find/contactus)  
(BP-9-7-17)



[www.keysight.com/go/quality](http://www.keysight.com/go/quality)  
Keysight Technologies, Inc.  
DEKRA Certified ISO 9001:2015  
Quality Management System

### myKeysight

#### myKeysight

[www.keysight.com/find/mykeysight](http://www.keysight.com/find/mykeysight)

A personalized view into the information most relevant to you.

[www.keysight.com/find/emt\\_product\\_registration](http://www.keysight.com/find/emt_product_registration)

Register your products to get up-to-date product information and find warranty information.

### KEYSIGHT SERVICES

Accelerate Technology Adoption.  
Lower costs.

#### Keysight Services

[www.keysight.com/find/service](http://www.keysight.com/find/service)

Keysight Services can help from acquisition to renewal across your instrument's lifecycle. Our comprehensive service offerings—one-stop calibration, repair, asset management, technology refresh, consulting, training and more—helps you improve product quality and lower costs.



#### Keysight Assurance Plans

[www.keysight.com/find/AssurancePlans](http://www.keysight.com/find/AssurancePlans)

Up to ten years of protection and no budgetary surprises to ensure your instruments are operating to specification, so you can rely on accurate measurements.

#### Keysight Channel Partners

[www.keysight.com/find/channelpartners](http://www.keysight.com/find/channelpartners)

Get the best of both worlds: Keysight's measurement expertise and product breadth, combined with channel partner convenience.

