

INCH-POUND

MIL-STD-1130C
31 January 2012
SUPERSEDING
MIL-STD-1130B
12 December 1978

DEPARTMENT OF DEFENSE
STANDARD PRACTICE

CONNECTIONS, ELECTRICAL,
SOLDERLESS WRAPPED

Reinstated after 16 August 2010 and may be used
for new and existing designs and acquisitions.



MIL-STD-1130C

FOREWORD

1. This standard is approved for use by all Departments and Agencies of the Department of Defense.
2. Comments, suggestions, or questions on this document should be addressed to: DLA Land and Maritime, ATTN: VAI, PO Box 3990, Columbus, OH 43218-3990, or emailed to rectangularconnector@dla.mil. Since contact information can change, you may want to verify the currency of this address information using the ASSIST Online database at <https://assist.daps.dla.mil/>.

MIL-STD-1130C

<u>Paragraph</u>	CONTENTS	PAGE
	Forward	ii
1	SCOPE -----	1
1.1	Scope -----	1
1.2	Classification -----	1
2	APPLICABLE DOCUMENTS -----	1
2.1	General -----	1
2.2	Government Documents -----	1
2.2.1	Specifications, standards and handbooks -----	1
2.3	Non-Government publications -----	1
2.4	Order of precedence -----	2
3	DEFINITIONS -----	2
3.1	Solderless wrapped, electrical connection -----	2
3.2	Class A (solderless wrapped electrical connection) (preferred method) -----	2
3.3	Class B (conventional solderless wrapped electrical connection) -----	2
3.4	End tail -----	2
3.5	A turn of wire -----	2
3.6	Gas-tight area -----	2
3.7	Reference corner -----	2
4	GENERAL REQUIREMENTS -----	4
4.1	Description -----	4
5	DETAIL REQUIREMENTS -----	5
5.1	Wire -----	5
5.1.1	Insulated and uninsulated wire -----	5
5.1.2	Insulation stripping -----	5
5.2	Wrappost -----	5
5.2.1	Wrappost geometry -----	5
5.2.2	Material -----	5
5.2.3	Parallelism -----	5
5.2.4	Tip configuration -----	5
5.2.5	Plating -----	5
5.2.5.1	Plating, gold -----	5
5.2.5.2	Plating, tin-lead -----	5
5.2.5.3	Caution note -----	5
5.3	Solderless wrapped connection -----	7
5.3.1	Process -----	7
5.3.1.1	Positioning of wire -----	8
5.3.1.2	Torque -----	8
5.3.2	Wire turns -----	8
5.3.2.1	Visual inspection criteria -----	9
5.3.3	Spacing of wrappost -----	11
5.4	Wrapping tool condition -----	12
5.4.1	Initial verification of process conditions -----	12
5.4.1.1	Verification of acceptable tool condition -----	12
5.4.2	Reverification of tool conditions -----	12
5.4.2.1	Reverification of process and conditions -----	12
5.5	Rewrapping -----	12
5.5.1	Rewrapping of wire -----	12
5.5.2	Rewrapping of wrappost -----	12

MIL-STD-1130C

Paragraph	CONTENTS	PAGE
5.6	Performance requirements of solderless wrapped connections -----	13
5.6.1	Strip force -----	13
5.6.2	Gas tight -----	14
5.6.3	Unwrap test -----	14
5.6.3.1	Unwrap test (conductor brittleness) -----	14
5.6.4	Wrapper resistance -----	15
6	NOTES -----	17
6.1	Subject term (key word) listing -----	17
6.2	Environmentally preferable material -----	17
6.3	Changes from previous issue -----	17

FIGURE

1.	Solderless wrapped connections on a square wrappost -----	3
2.	Typical connections -----	5
3.	Diagonal dimension -----	6
4.	Solderless wrapped connection process -----	7
5.	Insufficient insulation wrap -----	9
6.	Overlap -----	9
7.	Improper spacing -----	9
8.	Insufficient turns -----	10
9.	End tail -----	10
10.	Overwrap -----	10
11.	Spiral wrap -----	11
12.	Open wrap -----	11
13.	Stripping test fixture -----	13
14.	Unwrap test procedure A -----	14
15.	Unwrap test procedure B -----	15
16.	Wrapper resistance test -----	16

TABLE

I.	Minimum wrappable length -----	5
II.	Wrappost geometry -----	6
III.	Number of turns -----	8
IV.	Strip-force limits -----	13
V.	Wrapper resistance -----	15

MIL-STD-1130C

1. SCOPE

1.1 Scope. This standard establishes the requirements to produce mechanically and electrically stable, solderless wrapped, electrical connections made with single, solid, round wire and appropriately designed wrapposts (terminals). This standard includes:

- a. Classes and requirements for solderless wrapped connections.
- b. Description and requirements for the wire used in making the solderless wrapped connections.
- c. Description and requirements for the wrappost used in making the solderless wrapped connections.

1.2 Classification. This standard covers the following classes of solderless wrapped, electrical connections:

- Class A – Solderless wrapped, electrical connections (see 3.2 for preferred method).
- Class B – Conventional solderless wrapped, electrical connections (see 3.3). Class A will be used whenever possible.

2 APPLICABLE DOCUMENTS

2.1 General. The documents listed in this section are specified in sections 3, 4, or 5 of this standard. This section does not include documents cited in other sections of this standard or recommended for additional information or as examples. While every effort has been made to ensure the completeness of this list, document users are cautioned that they must meet all specified requirements of documents cited in sections 3, 4, or 5 of this standard, whether or not they are listed.

2.2 Government documents.

2.2.1 Specifications, standards and handbooks. The following specifications, standards, and handbooks form a part of this document to the extent specified herein. Unless otherwise specified, the issues of these documents are those cited in the solicitation or contract.

FEDERAL STANDARD

FED-STD-228 - Cable and Wire, Insulated; Methods of Testing.

DEPARTMENT OF DEFENSE SPECIFICATION

MIL-DTL-45204 - Gold Plating, Electrodeposited.

(Copies of these documents are available online at <https://assist.daps.dla.mil/quicksearch/> or from the Standardization Document Order Desk, 700 Robbins Avenue, Building 4D, Philadelphia, PA 19111-5094.)

2.3 Non-Government publications. The following documents form a part of this document to the extent specified herein. Unless otherwise specified, the issues of these documents are those cited in the solicitation or contract.

MIL-STD-1130C

SAE INTERNATIONAL

- SAE-AMS-QQ-N-290 - Nickel Plating (Electrodeposited).
- SAE-AMS-P-81728 - Plating, Tin Lead (Electrodeposited).
- SAE-AS81822 - Wire, Electrical, Solderless Wrap, Insulated and Uninsulated.

(Copies of these documents are available on line at www.sae.org from SAE International, 400 Commonwealth Drive, Warrendale, PA 15096-0001, and Tel: 877-606-7323 [inside USA and Canada] or 724-776-4970 [outside USA], email at CustomerService@sae.org.)

2.4 Order of precedence. Unless otherwise noted herein or in the contract, in the event of a conflict between the text of this document and the references cited herein, the text of this document takes precedence. Nothing in this document, however, supersedes applicable laws and regulations unless a specific exemption has been obtained

3. DEFINITIONS

3.1 Solderless wrapped, electrical connection. The terminology and makeup of this type of connection on one type of wrappost configuration is illustrated on [figure 1](#).

3.2 Class A (solderless wrapped electrical connection) (preferred method). This connection consists of a helix of continuous, solid, uninsulated wire tightly wrapped around the wrappost of a solderless wrapped contact to produce a mechanically and electrically stable connection. The number of turns required will depend on the gage of wire used (see [5.3.2](#)). In addition to the length of uninsulated wire wrapped around the wrappost, an additional minimum half turn of insulated wire shall be wrapped around the wrappost to help insure better vibration characteristics. To accomplish a half turn, the wire must be in contact with at least three corners of the wrappost. (See [figure 1](#).)

3.3 Class B (conventional solderless wrapped electrical connection). This connection is the same as described in class A (see [3.2](#)) except that the additional half turn of insulated wire is not required. (See [figure 1](#).)

3.4 End tail. An end tail is the end of the last turn of wire of a solderless wrapped connection which may extend in a tangential direction instead of resting against the wrappost. (See [figure 1](#).)

3.5 A turn of wire. A turn of wire shall consist of one complete, single helical ring of wire wrapped 360° around the wrappost. For the purpose of counting turns, the number of times the wrapped wire passes and intercepts the reference edge of the wrappost after the first intercept of uninsulated wire and wrappost shall constitute the number of turns of uninsulated wire in the connection.

3.6 Gas-tight area. The gas-tight area is that contact area between the wrappost and wire which, due to the quality of the wrap, will exclude gas fumes. (See [5.6.2](#).)

3.7 Reference corner. The corner at which the first turn of uninsulated wire intercepts is the reference corner.

MIL-STD-1130C

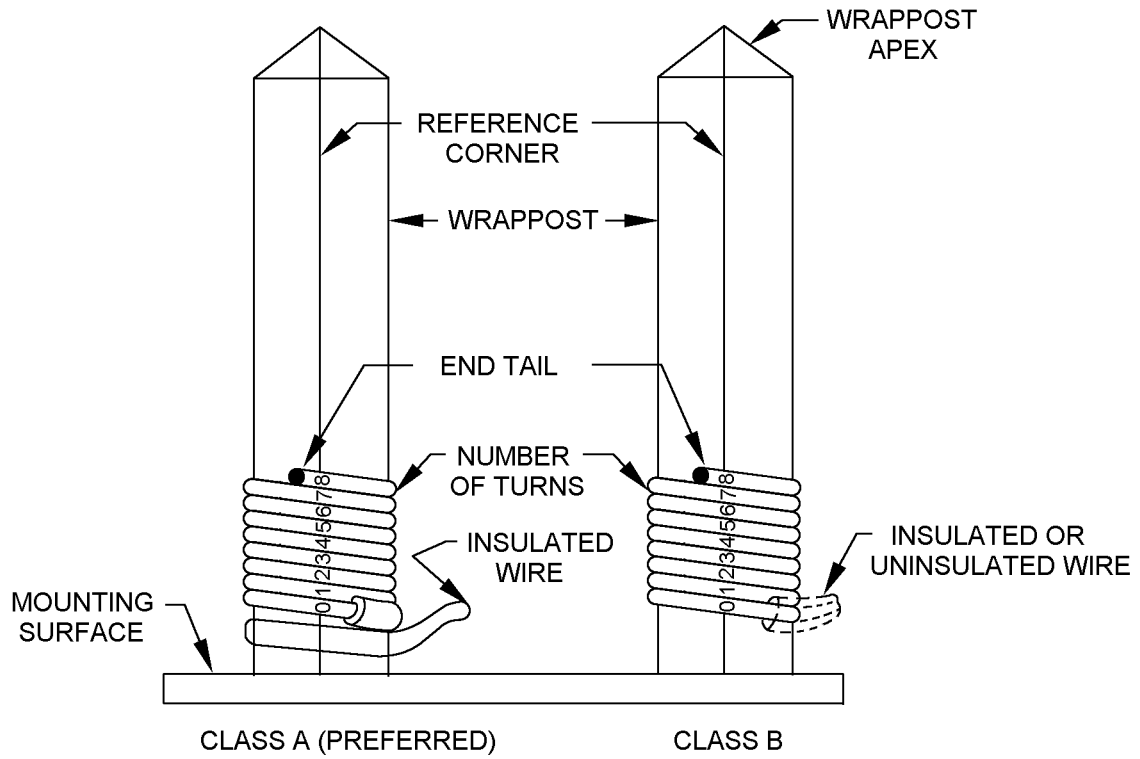

FIGURE 1. Solderless wrapped connections on a square wrappost.

MIL-STD-1130C

4. GENERAL REQUIREMENTS

4.1 Description. Solderless wrapped connections shall be made by wrapping a specified number of turns of wire, under tension, around a post having sharp corners. The sharp corners of the wrappost shall produce high pressure points resulting in indentations of the wire or both the wire and wrappost to meet the requirements of the strip test (see [5.6.1](#)). The resulting gas-tight, high-pressure points shall provide electrical continuity and mechanical stability. Wrappost connections covered by this standard shall be either class A or B (see [3.6](#) and [5.6.2](#)).

- a. Class B wire wraps may be used only in instances where class A wire wraps cannot be accomplished, such as uninsulated wire and coaxial cables.

MIL-STD-1130C

5. DETAIL REQUIREMENTS

5.1 Wire.

5.1.1 Insulated and uninsulated wire. Wire for solderless wrapped electrical connections shall conform to SAE-AS81822.

5.1.2 Insulation stripping. The insulation shall be removed by manual or automatic tools. Prior to wrapping there shall be no exposure of the base metal. The length of the insulation stripped away shall be as required for the number of turns as specified in 5.3.2. The insulation shall not be bonded to the conductor.

5.2. Wrappost.

5.2.1 Wrappost geometry. Unless otherwise specified in the applicable procurement document, the wrappost shall be in accordance with figures 2 and 3, table I and table II.

5.2.2 Material. Wrapposts material shall be as specified in the applicable connector specification.

5.2.3 Parallelism. See figure 2 and table II.

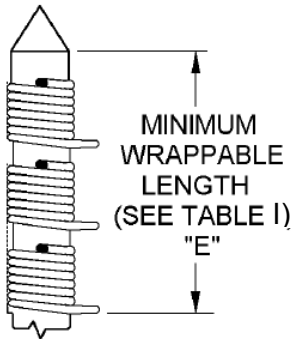
TABLE I. Minimum wrappable length, -E, inches ^{1/}

Number of wrapped connections	Wire gauge						
	30	28	26	24	22	20	18
1	.185	.219	.226	.258	.303	.327	.391
2	.320	.388	.402	.466	.556	.604	.732
3	.455	.557	.578	.674	.809	.881	1.073

^{1/} Minimum wrappable length shall have the wrappost geometry in accordance with table II.

FIGURE 2. Typical connection.

MIL-STD-1130C

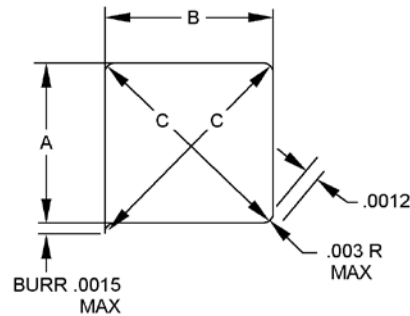
FIGURE 3. Diagonal dimension.TABLE II. Wrappost geometry.

A	B	C	Parallelism	Straightness in/in
.025 (nominal) .022 Min.	.025 (nominal) .022 Min.	.0355 Max. .0325 Min.	.002	.005 in/in
.045 (nominal) .042 Min.	.045 (nominal) .042 Min.	.066 Max. .059 Min.	.005	.005 in/in
.030 (nominal) .027 Min.	.060 (nominal) .057 Min.	.070 Max. .063 Min.	.005	.005 in/in

5.2.4 Tip configuration. The tip of the wrappost shall terminate in a radius or bevel to facilitate insertion into the wrapping tool. If the tip of the wrappost terminates in a bevel, the apex of the bevel shall be flat, with no side of the flat exceeding .015 inches (.38 mm) on a .025 inch (.64 mm) square and .020 inches (.51 mm) on a .045 inch (1.14 mm) square and .06 inch (1.52 mm) x .03 (.76 mm) rectangle.

5.2.5 Plating. Wrappost shall be plated in accordance with one of the following:

5.2.5.1 Plating, gold. Gold plating shall be in accordance with MIL-DTL-45204, class 1, over nickel in accordance with SAE-AMS-QQ-N-290. Thickness of nickel plating shall be a minimum of 30 microinches.

5.2.5.2 Plating, tin-lead. Tin-lead plating shall be in accordance with SAE-AMS-P-81728 and shall have a tin composition of 50 to 95 percent. Tin-lead plating thickness shall be .0001 to .0003 inch thick.

5.2.5.3 Caution note. Silver underplating shall not be used in any case.

MIL-STD-1130C

5.3 Solderless wrapped connection.

5.3.1 Process. Solderless wrapped connections shall be made with either hand or automatic wrapping tools capable of wrapping connections which conform to all requirements of this standard. The sequence of operations for making wrapped connections shall be as follows (see figure 4).

- a. Verify that the tool meets the requirements specified in 5.4.
- b. Insert the stripped wire into the feed slot (hand tools only).
- c. Bend insulated or bare wire into notch in tool to anchor (hand tools only).
- d. Place tool (large hole) over the wrappost.
- e. Rotate the tool spindle around the wrappost.
- f. Remove tool from wrappost.

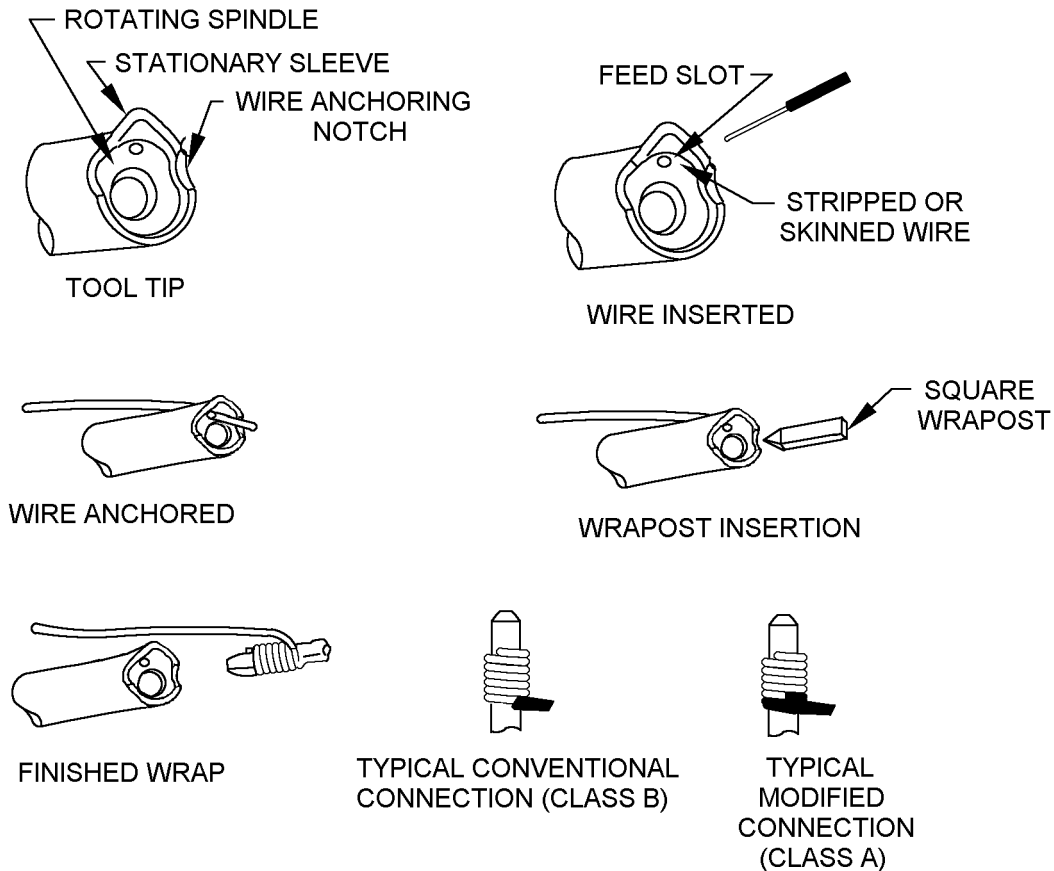

FIGURE 4. Solderless wrapped connection process.

MIL-STD-1130C

5.3.1.1 Positioning of wire. Prior to wrapping, the wire shall be positioned radially so that subsequent routing of the unwrapped portion of the wire does not tend to unwrap the connection.

5.3.1.2 Torque. The wrappost shall withstand the following torque without permanent rotation or twisting relative to the mounting surface.

Wrappost size	Minimum torque
0.025 (0.64) square	2.0 ounce – inches
0.045 (1.14) square	8.0 ounce – inches
0.06 (1.53) x 0.03 (0.76)	8.0 ounce – inches

5.3.2 Wire turns. Table III specifies the number of turns which are to be used when making modified and conventional connections. Except for the first and last-half turns of uninsulated wire, the maximum space between adjacent turns of uninsulated wire shall not exceed one half the nominal diameter of the uninsulated wire. This requirement applies only to the minimum number of turns specified in table III. There shall be no overlap of turns to the last locked point (last wrappost corner) within the minimum turns specified. However, the end tail shall not extend away from the outside diameter of the stripped wire on the wrappost by more than the diameter of the stripped wire.

TABLE III. Number of turns.

Wire size	Diameter		Minimum number of turns (See figure 1 & 3.1)	
	Inches	(mm)	Class A	Class B
30 ^{1/}	.010	(.025)	7 stripped turns plus 1/2 insulated	7 stripped turns
28 ^{1/}	.0126	(.32)	7 stripped turns plus 1/2 insulated	7 stripped turns
26	.0159	(.40)	6 stripped turns plus 1/2 insulated	6 stripped turns
24	.0201	(.51)	5 stripped turns plus 1/2 insulated	5 stripped turns
22 ^{1/}	.0253	(.64)	5 stripped turns plus 1/2 insulated	5 stripped turns
20 ^{1/}	.0320	(.81)	4 stripped turns plus 1/2 insulated	4 stripped turns
18 ^{1/}	.0403	(1.02)	4 stripped turns plus 1/2 insulated	4 stripped turns

^{1/} For .045 x .045 and .030 x .060 wrapposts, 30 and 28 wire sizes are not recommended for use. For .025 x .025 wrappost, 22, 20 and 18 wire sizes are not recommended for use.

MIL-STD-1130C

5.3.2.1 Visual inspection criteria. All solderless wrapped connections shall visually conform to the requirements of this document. The following defects detectable by visual inspection shall be cause for rejection.

- a. No insulation or insufficient insulation in contact with wrappost. (See figure 5.)

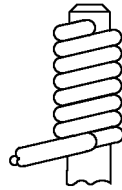
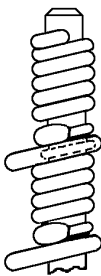
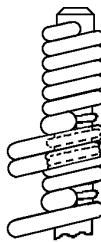

FIGURE 5. Insufficient insulation wrap.

- b. Improper wrapper spacing and overlapped wrappers. There shall be no overlapping within the minimum specified number of turns of uninsulated wire except that the first turn of insulated wire in a modified solderless wrapped connection may overlap the last turn of uninsulated wire in a connection below it on the same terminal. Insulation must make contact bite with a minimum of three corners. (See figures 6 and 7.)



ACCEPTABLE



REJECTION

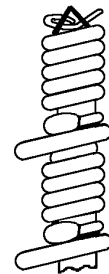

FIGURE 7. Improper spacing.

FIGURE 6. Overlap.

MIL-STD-1130C

- c. Insufficient number of wrapper turns. (See 5.3.2 and figure 8.)

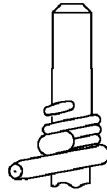

FIGURE 8. Insufficient turns.

- d. End tail (see 3.4) not conforming to the requirements as specified in 5.3.2. (See figure 9.)

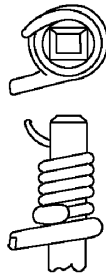

FIGURE 9. End tail.

- e. Overlapping wrapper turns within a wrapper level. (See figure 10.)



FIGURE 10. Overwrap.

MIL-STD-1130C

- f. Space between adjacent wrapper turns exceeding one half the diameter of the uninsulated conductors. (See figures 11 and 12.) The sum of all gaps should not exceed one wire diameter; excluding the first and last turn.

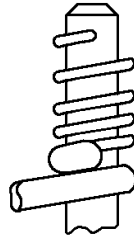

FIGURE 11. Spiral wrap.

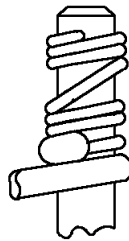

FIGURE 12. Open wrap.

- g. The wire shall not be routed in any manner which will tend to unwrap the wire

5.3.3 Spacing of wrappost. Wrappost spacing shall allow sufficient room to accommodate the wrapping tool.

MIL-STD-1130C

5.4 Wrapping tool condition.5.4.1 Initial verification of process conditions.

5.4.1.1 Verification of acceptable tool condition. The capability of the wrapping tools to provide acceptable solderless wrapped, electrical connection shall be established at a facility acceptable to the procuring activity for each combination of wrappost (based on cross sectional geometry), wire gauge, and wrapping bit and sleeve configuration by inspecting 24 sample connections to the following requirements:

Number of samples to be inspected	Requirement
6	Strip force, see 5.6.1
6	Gas-tight, see 5.6.2
6	Unwrap, see 5.6.3
6	Wrapper resistance, see 5.6.4

Acceptance of the sample connections shall constitute initial verification of acceptable tool condition.

5.4.2 Reverification of tool conditions.

5.4.2.1 Reverification of process and conditions. Following initial verification of tool condition, samples shall be inspected in accordance with the following requirements at the time intervals specified as follows:

Number of samples to be inspected	Requirement	Inspection interval
6	Strip force, see 5.6.1	Daily
6	Unwrap, see 5.6.3	Daily
6	Gas-tight, see 5.6.2	Six months
6	Wrapper resistance, see 5.6.4	Six months

Acceptance of sample connections shall constitute reverification of acceptable tool condition.

5.5 Rewrapping.

5.5.1 Rewrapping of wire. It is not permissible to rewrap the portion of wire that has been previously wrapped on a wrappost.

5.5.2 Rewrapping of wrappost. Wraps can be made on the same portion of a wrappost from which a previously made solderless wrapped connection has been unwrapped (pull-off or stripping is not allowed). The connections must be capable of meeting the requirements of this standard.

MIL-STD-1130C

5.6 Performance requirements of solderless wrapped connections.

5.6.1 Strip force. A completed solderless wrapped connection, with the minimum number of turns listed in table II, shall be capable of meeting the minimum strip force specified in table IV. The minimum strip force shall be obtained before the wrapped connection has been moved along the wrappost a length equivalent to the diameter of the conductor used on the wrappost. The samples shall be tested using a test fixture illustrated in figure 13. The clearance between the wrappost and the test fixture jaws shall not exceed 70 percent of the wire diameter. The stripping force shall be applied at a uniform rate of 1 to 10 inches per minute.

TABLE IV. Strip-force limits.

Wire size	Conductor diameter		Minimum strip force (pounds)		
	Inches	(mm)	0.025 Square	0.045 Square	0.06 x 0.03
30	0.010	(0.25)	2.0	-	-
28	0.0126	(0.32)	3.0	-	-
26	0.0159	(0.40)	4.0	-	6.0
24	0.201	(0.51)	5.0	-	7.0
22	0.0253	(0.64)	-	-	8.0
20	0.0320	(0.81)	-	-	9.0
18	0.0403	(1.02)	-	-	15.0

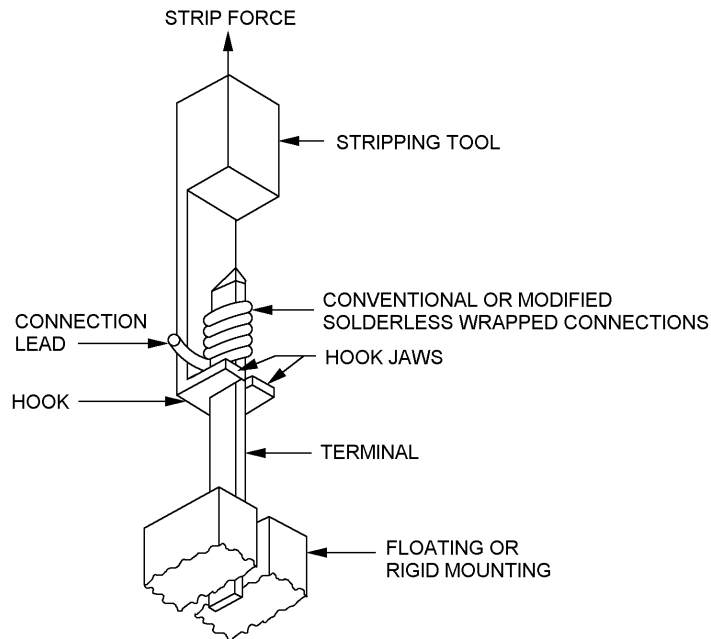
FIGURE 13. Stripping test fixture.

MIL-STD-1130C

5.6.2 Gas tight. Seventy five percent of the corners in contact with uninsulated wire, except for the first and last turn, shall be gas tight when tested as follows:

Darken the assembly with ammonium sulphide gas after wrappost is exposed to aqua regia fumes.

- a. The wrappost shall be suspended and corked in a 16 x 150 millimeter (mm) test tube containing approximately 1 to 2 milliliters (ml) of aqua regia solution (1:1 concentrated hydrochloric and nitric acids). The solution must not touch the wrappost assemblies. The wrappost assemblies shall be exposed to the aqua regia fumes for 10 minutes.
- b. The chemically attached wrappost shall be transferred to another 16 x 150 mm test tube containing approximately 1 ml of concentrated ammonium sulphide solution. Suspend the wrappost connections in the test tube so that they will not touch the ammonium sulphide solution. Close the test tube with a cork or rubber stopper and leave the specimens exposed to this atmosphere until they turn dark. Copper and gold sulphide color will be developed on all areas exposed to vapor.
- c. Dry and unwrap the connections with a tool which does not scratch the post. The gastight areas will appear in bright, sharp contrast with discolored area.

5.6.3 Unwrap test. Wire on wrappost shall be capable of being unwrapped without conductor breakage. (See figures 14 and 15).

5.6.3.1 Unwrap test (conductor brittleness). Place the unwrapping tool over the terminal post and engage its leading edge between the wrap end and the next wrap turn. Rotate the unwrapping tool until all the wire has been transferred onto the tool. Remove the tool with the loose helical coil from the terminal post. Holding the insulated portion of the wire firmly, rotate the tool unwinding the wire. The unwrapped wire need not be perfectly straight; waves and permanent deformation in it are permissible.

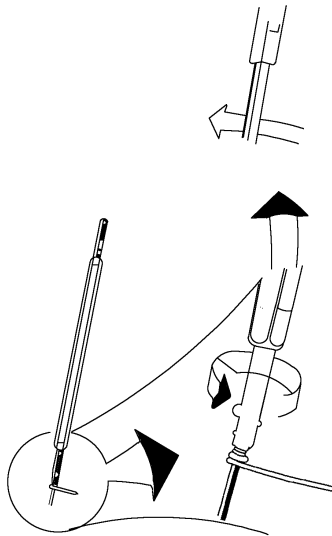
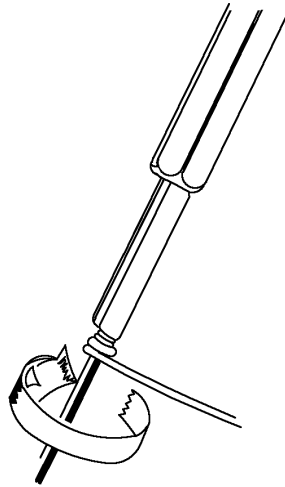

FIGURE 14. Unwrap test procedure A (see 5.6.3).

MIL-STD-1130C

FIGURE 15. Unwrap test procedure B (see 5.6.3.)

5.6.4 Wrapper resistance. When measured as illustrated on [figure 16](#), at the current specified in table V, the voltage drop across the wrapped connection shall not exceed 4 millivolts.

TABLE V. Wrapper resistance.

AWS wire size	Conductor diameter		Current to be used to determine wrapper resistance (amperes)
	inches	(mm)	
30	0.010	(0.25)	1.0
28	0.0126	(0.32)	2.0
26	0.0159	(0.40)	2.4
24	0.0201	(0.51)	2.4
22	0.0253	(0.64)	2.4
20	0.0320	(0.81)	7.5
18	0.0403	(1.02)	7.5

NOTES:

1. The stripping jaw shall engage at right angles to axis of the wrappost.
2. When the wrappost and stripping fixture are properly aligned, the clearance shall be such that there is no binding or wedging between jaw and wrapper.
3. Both sides of the stripping jaw shall be in the same plane, creating a flat surface contact with the wire on either side of the wrappost.
4. On a rectangular post, the jaws of the hook shall engage along the major dimension (cross section) of the terminal. The maximum total clearance between jaw and terminal shall not exceed 0.7 x diameter of the wire. The minimum clearance, when the terminal and stripping tool are properly aligned, shall be such that there is no binding between jaw and terminal.

MIL-STD-1130C

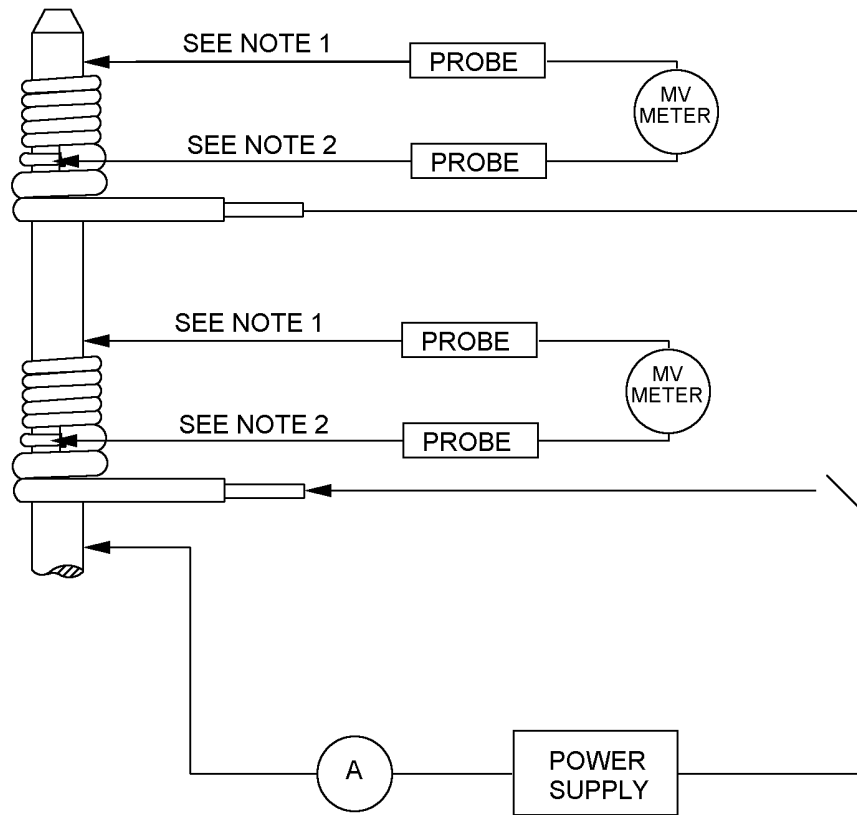

NOTES:

1. This probe shall not touch the wire.
2. This probe shall be placed on the first turn of uninsulated wire.

FIGURE 16. Wrapper resistance test.

MIL-STD-1130C

6. NOTES

(This section contains information of a general or explanatory nature that may be helpful, but is not mandatory.)

6.1 Intended use. This standard identifies the requirements for proper wire wrapping techniques to ensure adequate connection between wire and wrappost terminations for military wire wrap connector applications.

6.2 Subject term (key word) listing.

Gas-tight
Insulation
Wire

6.3 Environmentally preferable material. Environmentally preferable materials should be used to the maximum extent possible to meet the requirements of this specification. As of the dating of this document, the U.S. Environmental Protection Agency (EPA) is focusing efforts on reducing 31 priority chemicals. The list of chemicals and additional information is available on their website at <http://www.epa.gov/osw/hazard/wastemin/priority.htm>. Included in the list of 31 priority chemicals are cadmium, lead, and mercury. Use of these materials should be minimized or eliminated unless needed to meet the requirements specified herein (see section 3).

6.4 Changes from previous issue. Marginal notations are not used in this revision to identify changes with respect to the previous issue due to the extent of the changes.

CONCLUDING MATERIAL

Custodians:
Army – CR
Navy – EC
Air Force – 85
DLA - CC

Preparing activity:
DLA - CC

(Project 5935-2011-001)

Review activities:
Army – AR, MI
Navy – AS, CG, MC, SH,
Air Force – 19, 99

NOTE: The activities listed above were interested in this document as of the date of this document. Since organizations and responsibilities can change, you should verify the currency of the information above using the ASSIST Online database at <https://assist.daps.dla.mil/>.